

**5' x 17' SKYLIGHT**  
S-517-3A

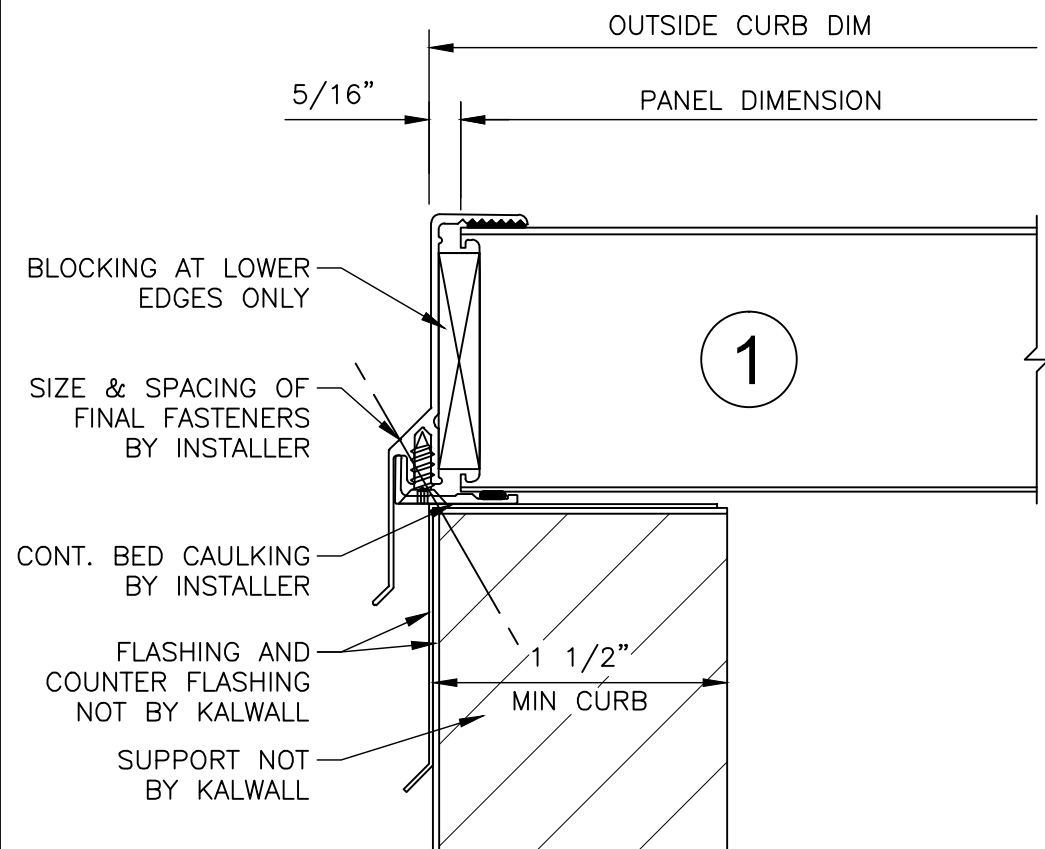

**KALWALL**<sup>®</sup>  
high performance translucent building systems