

5' x 12' SKYLIGHT
S-512-3A

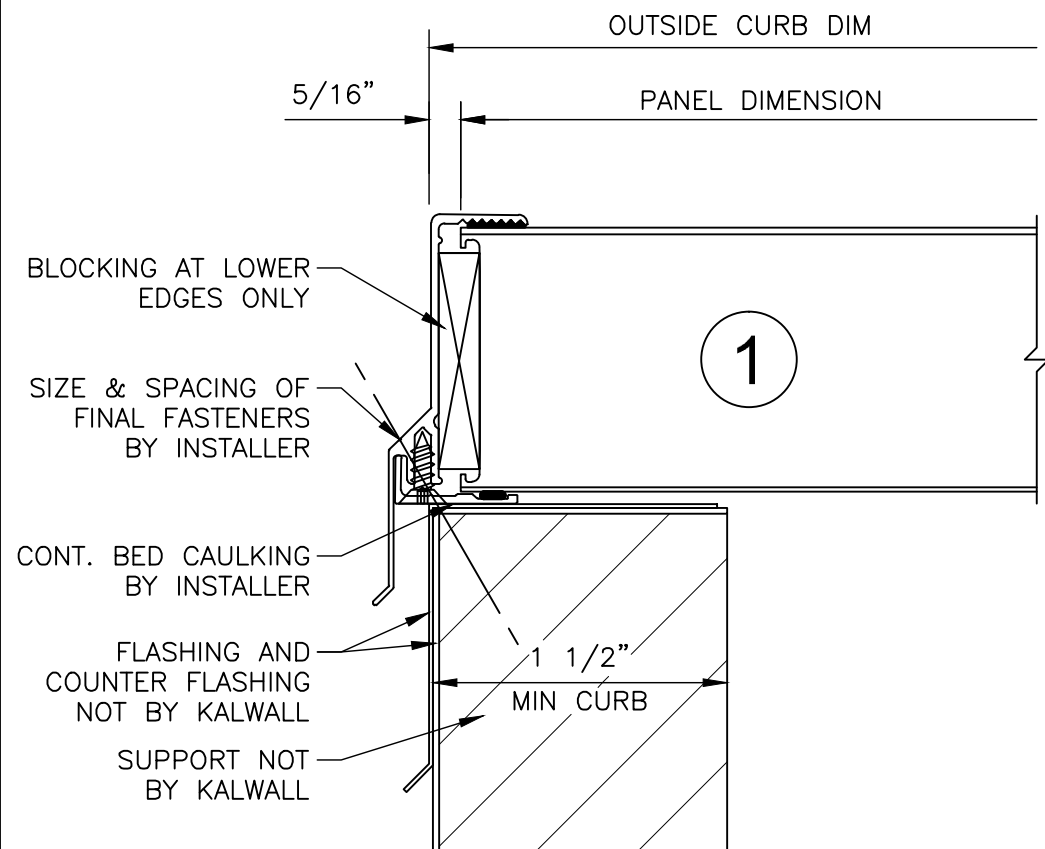

KALWALL[®]
high performance translucent building systems