

45° - 10'-0" PYRAMID

**** SHOP NOTE ****
4K1 UNITS HAVE INTERIOR ANGULAR BATTENS FACTORY ATTACHED (SEE DETAIL)

**** INSTALLER NOTE ****
ASSEMBLE 4K1 UNITS TO COMPRESSION RIB AND CURB BEFORE 4K2 UNITS

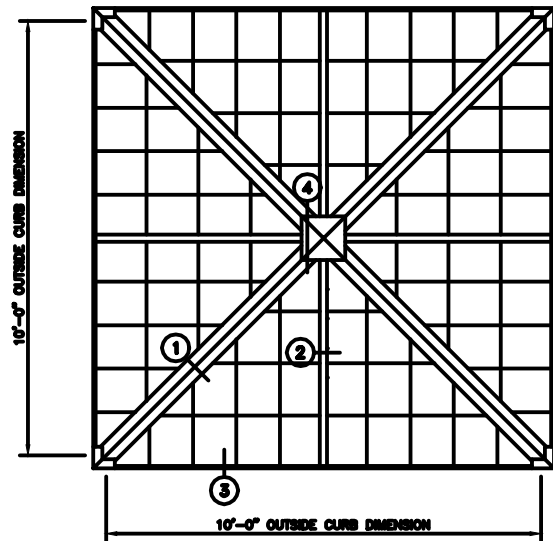

PYRAMID PLAN
NOTE: SHIPPED IN 4 UNITS

45° SLOPE
45° SLOPE

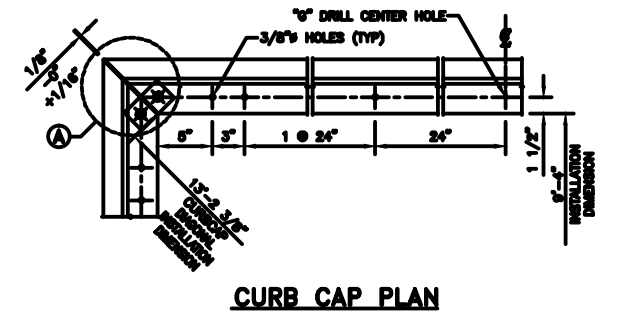
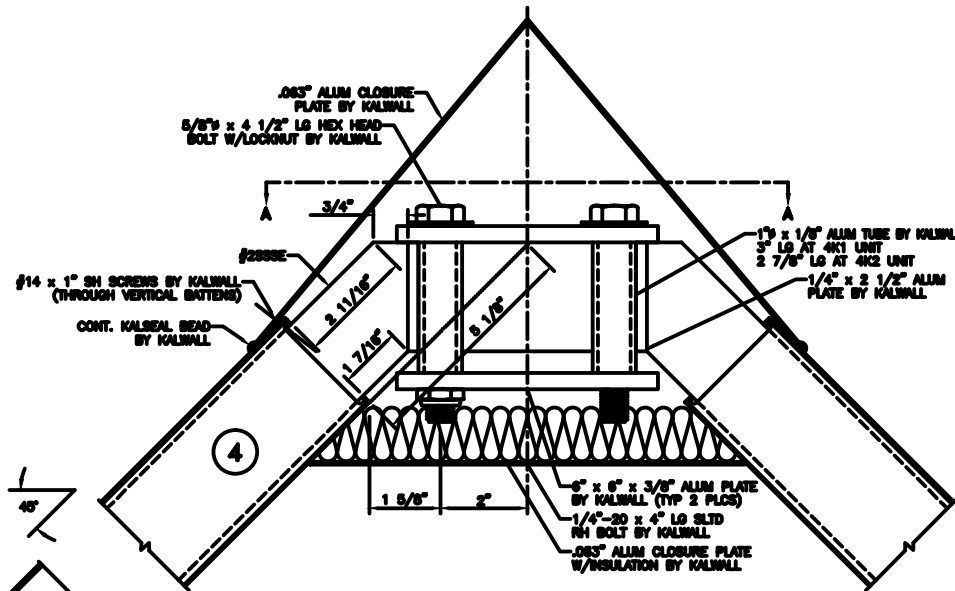
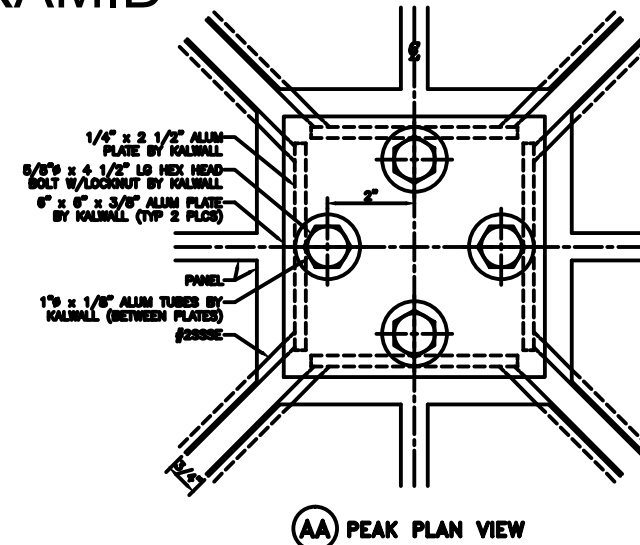

SUGGESTED FASTENING OF CURB CAP TO CURB

CURB TYPE	FASTENER & SPACING
WOOD	#14 R.H. S.S. - 4" L.G. 24" O.C.
STEEL	#14 R.H. S.S. - 1" L.G. 24" O.C.
CONCRETE	1/4" x 3 1/4" POWER STUD ON #4001 24" O.C.

NOT SUPPLIED BY KALWALL UNLESS INSTALLED BY KALWALL
ALL FASTENERS TO BE IN HOLE 1/8" LARGER THAN FASTENER DIA.
HOLE AT CENTER OF CURB TO BE SAME DIA. AS FASTENER

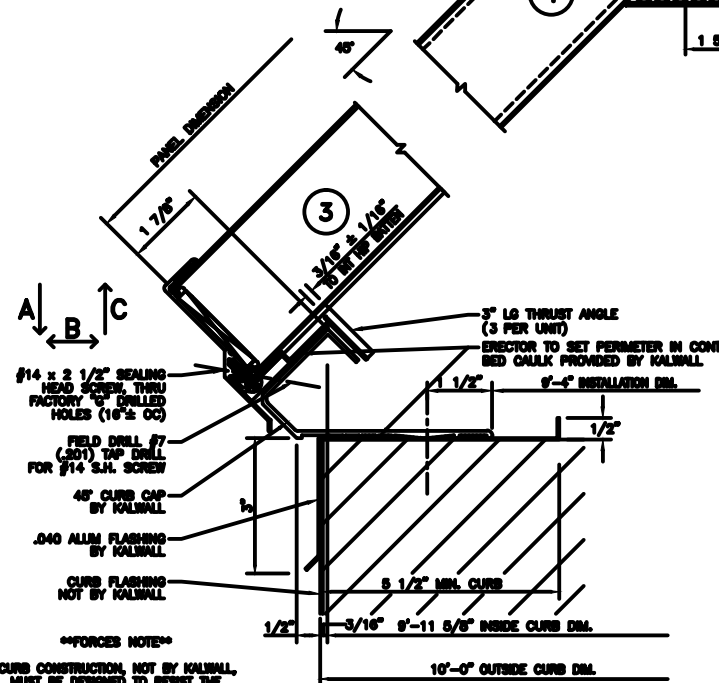
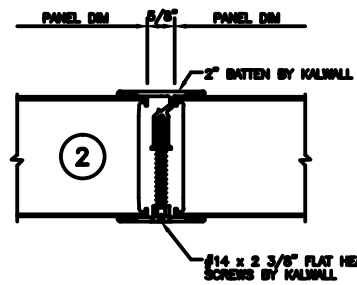
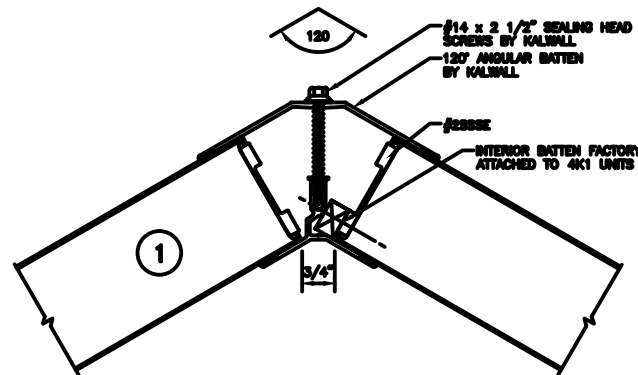

****FORCES NOTE****
CURB CONSTRUCTION, NOT BY KALWALL, MUST BE DESIGNED TO RESIST THE FOLLOWING FORCES PRODUCED BY

A: PEF LIVE LOAD
A: PEF SNOW LOAD
A: PEF DRIFT LOAD

A: _____ LBS/SIDE
B: _____ LBS/SIDE
C: _____ LBS/SIDE

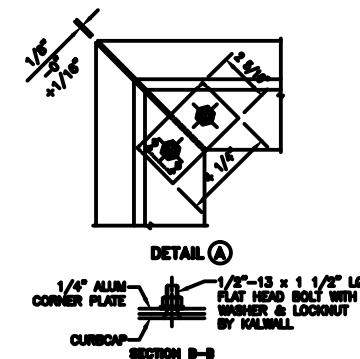

KALWALL[®]
high performance translucent building systems