

5' x 20' SKYLIGHT
S-520-3A

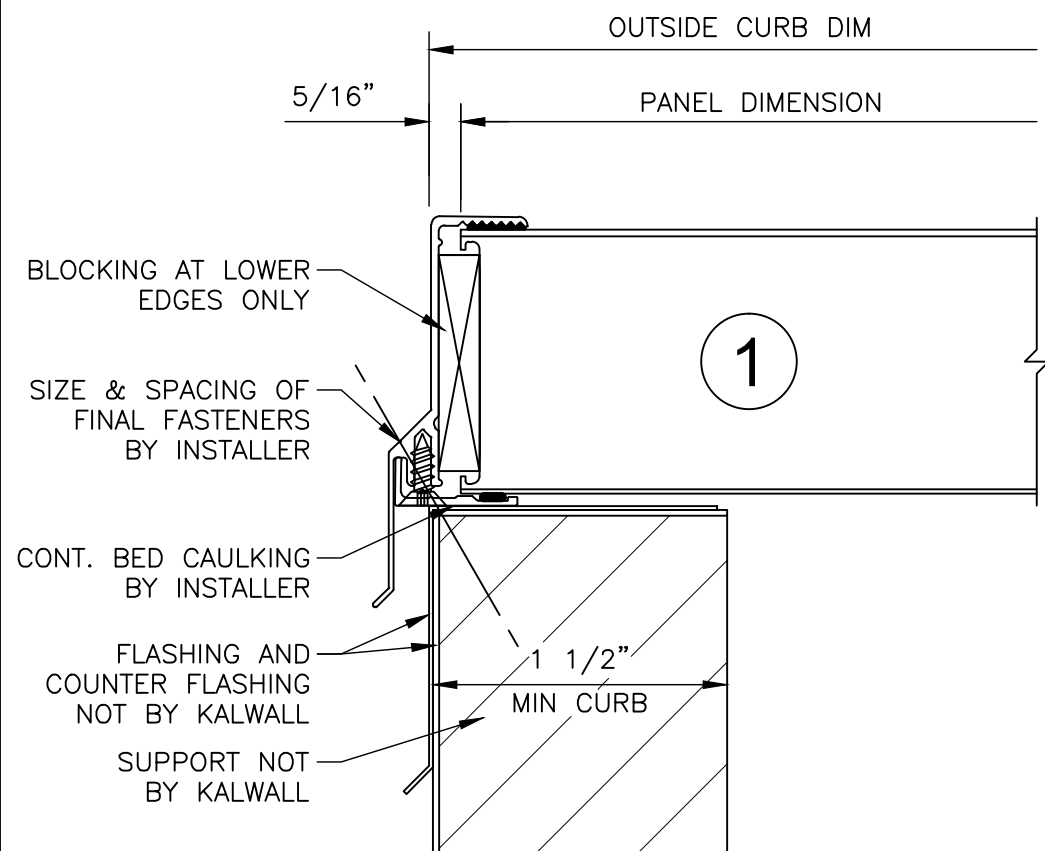

KALWALL[®]
high performance translucent building systems